

PRODUCT NO. DSIC04LJGET	RoHS compliant
-----------------------------------	-----------------------

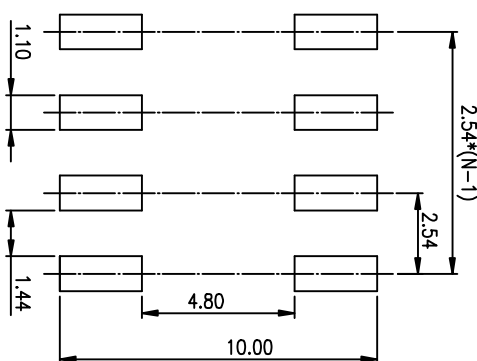

RECOMMENDED P.C.B. LAYOUT (TOP VIEW)

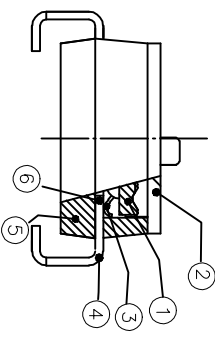
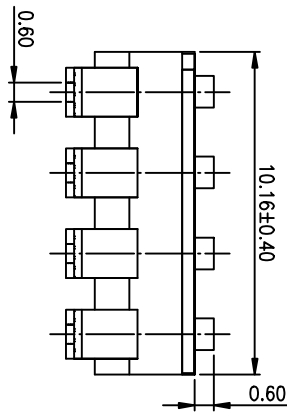
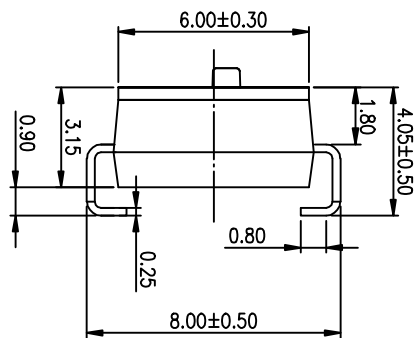
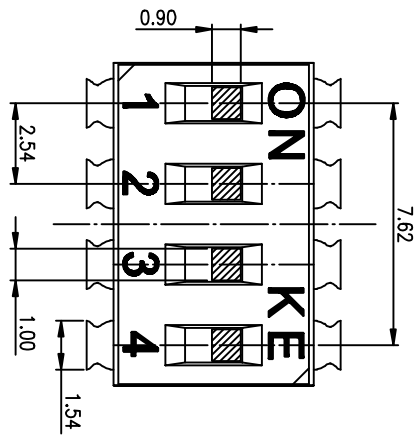
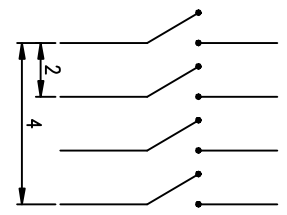

[Schematic]

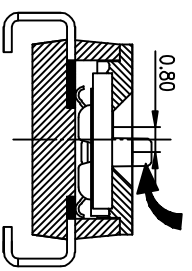

[装配行程]

- NOTES :
- 1> Specification:
 - 1> Operating force: 1000gf Max
 - 2> Operating Temperature: -40° to +85°
 - 3> Storage Temperature: -40° to +85°
 - 4> Mechanical Life: 3000cycles minimum
 - 5> Electrical Life: 2000cycles 25mA 24VDC
 2. PLATING:
 - GOLD FLASH 1u"(min.) SOLDER TAIL,
 - 3u" GOLD PLATING ON THE CONTACT AREA,
 - WITH 50u" NICKEL UNDERPLATING OVERALL.

3. PART NUMBER DESCRIPTION

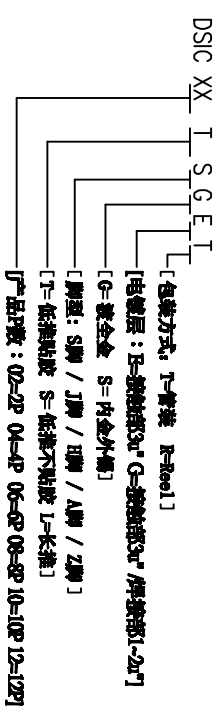

Number	Part Name	Material	Finished
①	Actuator	UL94 V0	White
②	Cover	UL94 V0	Black
③	Movable	Copper Alloy	3u"Gold
④	Terminal	Brass	1u"Gold
⑤	Base	UL94 V0	Black
⑥	Terminal Contact	Brass	3u"Gold

TOLERANCE UNLESS OTHERWISE SPECIFIED		INSPECTION COPY	
LINER	ANGLES	PROJECTION	
0 ± 0.25	0. ± 2°		
.00 ± 0.15	.0 ± 1°		
.000 ± 0.10	.00 ± 0.5°		
DESIGN	kathy	2012/04/12	
DRAWING			
CHECK			
APPRO.			

东莞市金捷电子有限公司 Dongguan Kingtek Industrial Co., Ltd.			
TITLE			
BY DSIC SERIES PITCH 2.54mm			
PRODUCT FAMILY DSIC SERIES			
PRAT NO. DSIC04LJGET			
FILE NO.	DSIC04LJGET-A	UNIT SCALE	SHEET REV.
SIZE	mm	2 : 1	1 OF 1 A