

PRODUCT NO.	DISCO4LHGET
ROHS COMPLIANT	RoHS compliant

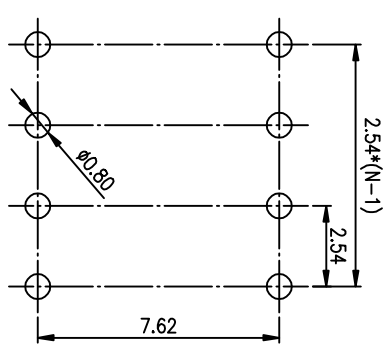

**RECOMMENDED P.C.B. LAYOUT (TOP VIEW)**

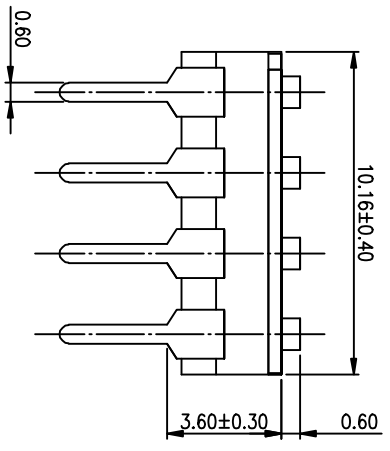
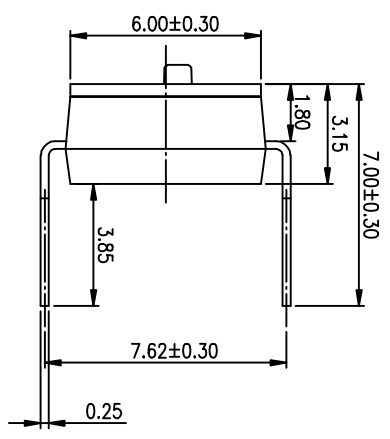
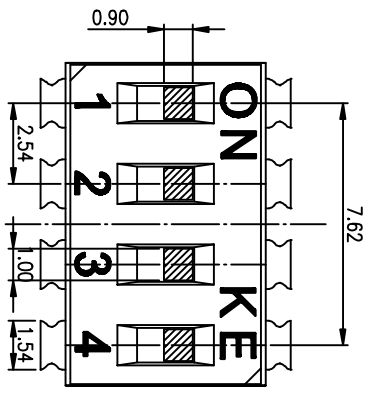
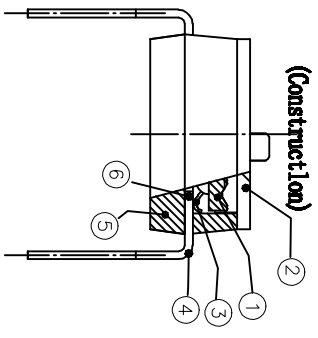

**(Construction)**

Number	Part Name	Material	Finished
①	Actuator	UL94 V0	White
②	Cover	UL94 V0	Black
③	Movable	Copper Alloy	3u"Gold
④	Terminal	Brass	1u"Gold
⑤	Base	UL94 V0	Black
⑥	Terminal Contact	Brass	3u"Gold

TOLERANCE UNLESS OTHERWISE SPECIFIED		INSPECTION	
LINER	ANGLES	COPY	PROJECTION
0 ± 0.25	0 ± 2'		
.00 ± 0.15	.0 ± 1'		
.000 ± 0.10	.00 ± 0.5'		
DESIGN	kathy	2012/04/12	
DRAWING			
CHECK			
APPRO.			

**RE** 總實特微電子股份有限公司  
Dongguan Kingtek Industrial Co., Ltd.

TITLE  
BY DISC SERIES PITCH 2.54mm

PRODUCT FAMILY DISC SERIES  
PRAT NO. DISCO4LHGET

FILE NO. DISCO4LHGET-A  
SIZE UNIT SCALE SHEET REV.  
A4 mm 2 : 1 1 OF 1 A

**NOTES :**

- 1> Specification:  
1> Operating force: 1000gf Max  
2> Operating Temperature: -40° to +85°  
3> Storage Temperature: -40° to +85°  
4> Mechanical Life: 3000cycles minimum  
5> Electrical Life: 2000cycles 25mA 24VDC
2. PLATING:  
GOLD FLASH 1u"(min.) SOLDER TAIL,  
3u" GOLD PLATING ON THE CONTACT AREA,  
WITH 50u" NICKEL UNDERPLATING OVERALL.

**3. PART NUMBER DESCRIPTION**

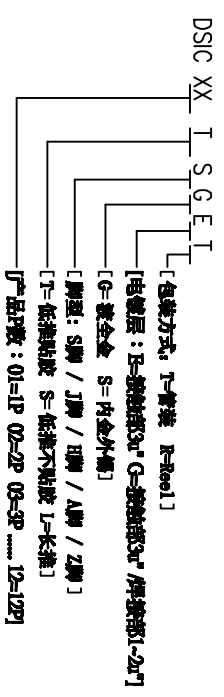

**[Schematic]**

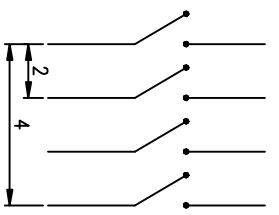

**[推釐行程]**

