

PRODUCT NO.	DISC03SUGET
NO.	1
RoHS compliant	

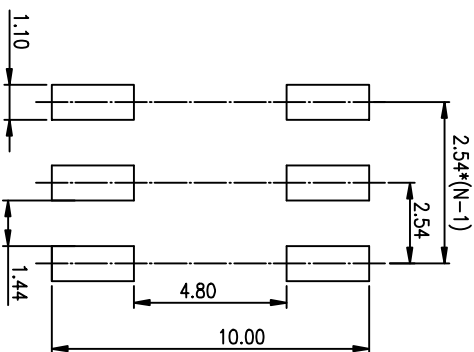

**RECOMMENDED P.C.B. LAYOUT (TOP VIEW)**

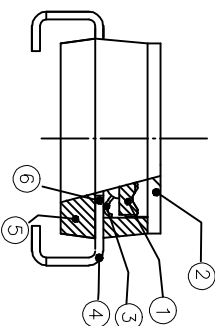
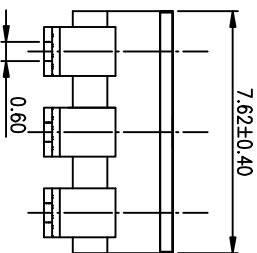
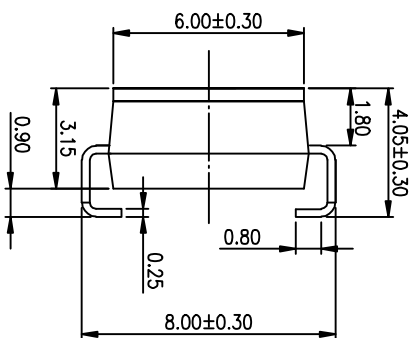
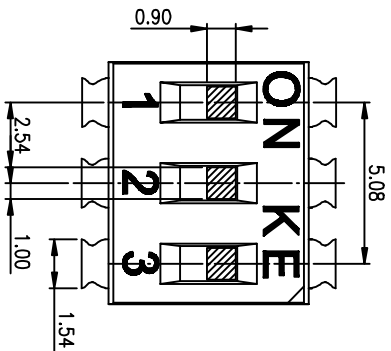
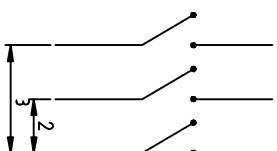

**[Schematic]**

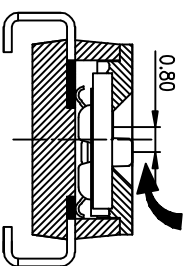

**[装配行程]**

- NOTES :
- 1>.Specification:
- 1>.Operating force:1000gf Max
  - 2>.Operating Temperature: -40° to+85°
  - 3>.Storage Temperature: -40° to+85°
  - 4>.Mechanical Life: 3000cycles minimum
  - 5>.Electrical Life: 2000cycles 25mA 24VDC
2. PLATING:
- GOLD FLASH 1u"(min.) SOLDER TAIL,  
3u" GOLD PLATING ON THE CONTACT AREA,  
WITH 50u" NICKEL UNDERPLATING OVERALL.

3. PART NUMBER DESCRIPTION

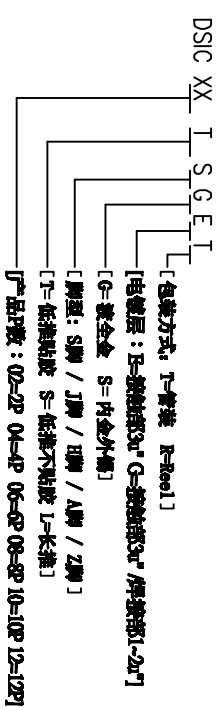

Number	Part Name	Material	Finished
①	Actuator	UL94 V0	White
②	Cover	UL94 V0	Black
③	Movable	Copper Alloy	3u"Gold
④	Terminal	Brass	1u"Gold
⑤	Base	UL94 V0	Black
⑥	Terminal Contact	Brass	3u"Gold

TOLERANCE UNLESS OTHERWISE SPECIFIED		INSPECTION COPY	
LINER	ANGLES	PROJECTION	COPY
0 ± 0.25	0. ± 2°	0	
.00 ± 0.15	.0 ± 1°	0.00 ± 0.10	
.000 ± 0.10	.00 ± 0.5°	DESIGN	2012/04/12
		DRAWING	
		CHECK	
		APPRO.	

**東富精機電子股份有限公司**  
Dongfuchen Kingtek Industrial Co., Ltd.

FILE NO. DISC03SUGET-A  
SIZE UNIT SCALE SHEET REV.  
A4 mm 2 : 1 10F-1 A