

PRODUCT NO. DSIC03LJGET	NO. 1	Revis compliant
-----------------------------------	-----------------	------------------------

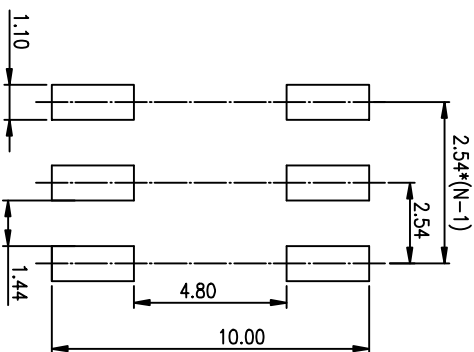

RECOMMENDED P.C.B. LAYOUT (TOP VIEW)

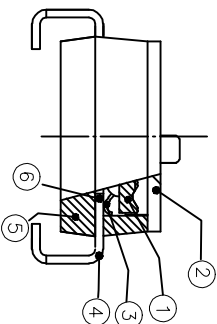
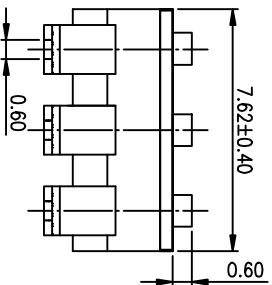
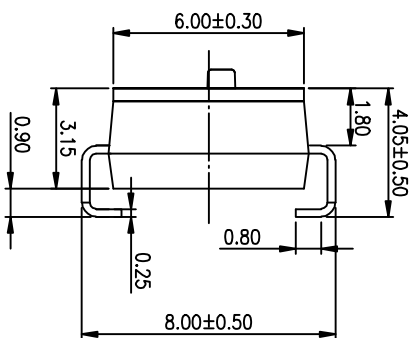
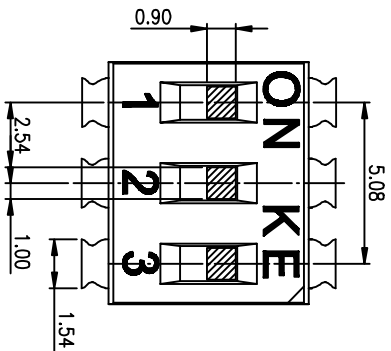
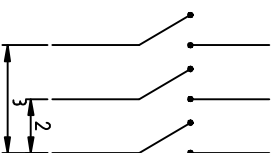

[Schematic]

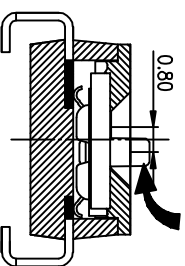

[推針行程]

- NOTES :**
- 1> Specification:
- 1> Operating force: 1000gf Max
 - 2> Operating Temperature: -40° to +85°
 - 3> Storage Temperature: -40° to +85°
 - 4> Mechanical Life: 3000cycles minimum
 - 5> Electrical Life: 2000cycles 25mA 24VDC
2. PLATING:
- GOLD FLASH 1u"(min.) SOLDER TAIL,
 - 3u" GOLD PLATING ON THE CONTACT AREA,
 - WITH 50u" NICKEL UNDERPLATING OVERALL.

3. PART NUMBER DESCRIPTION

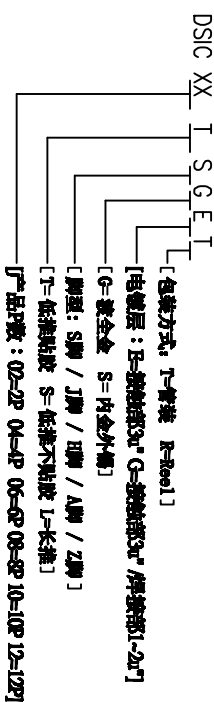

Number	Part Name	Material	Finished
①	Actuator	UL94 V0	White
②	Cover	UL94 V0	Black
③	Movable	Copper Alloy	3u"Gold
④	Terminal	Brass	1u"Gold
⑤	Base	UL94 V0	Black
⑥	Terminal Contact	Brass	3u"Gold

TOLERANCE UNLESS OTHERWISE SPECIFIED		INSPECTION COPY	
LINER	ANGLES	PROJECTION	COPY
0 ± 0.25	0. ± 2°	①	
.00 ± 0.15	.0 ± 1°	②	
.000± 0.10	.00± 0.5°	③	
DESIGN	kathy	2012/04/12	
DRAWING			
CHECK			
APPRO.			

東富精工電子股份有限公司
Dongguan Kingtek Industrial Co., Ltd.

東富精工電子股份有限公司
BY DSIC SERIES PITCH 2.54mm
PRODUCT FAMILY DSIC SERIES
PRAT NO. DSIC03LJGET
FILE NO. DSIC03LJGET-A
SIZE UNIT SCALE SHEET REV.
A4 mm 2 : 1 10F 1 A